



## Crane Merchant Ambient MEDIA2 Model 186/187

# ELEVATE THE CONSUMER EXPERIENCE LIKE NEVER BEFORE

## INTRODUCING THE REDESIGNED MERCHANT AMBIENT

Enabled for suggestive selling and digital advertising, the MEDIA2 screen on the CPI Merchant Ambient refrigerated vending machine lets you engage with consumers like never before. Merchant Ambient delivers:

### Faster Performance

The unit combines unparalleled product delivery speed, reliability, and on-screen responsiveness.

### Higher Engagement

A larger, 9-inch color touchscreen with full-motion video attracts consumers.

### Increased Sales

Suggestive selling and digital advertising drives impulse buys and add-on sales.

**Increase your revenue potential with  
Merchant Ambient**

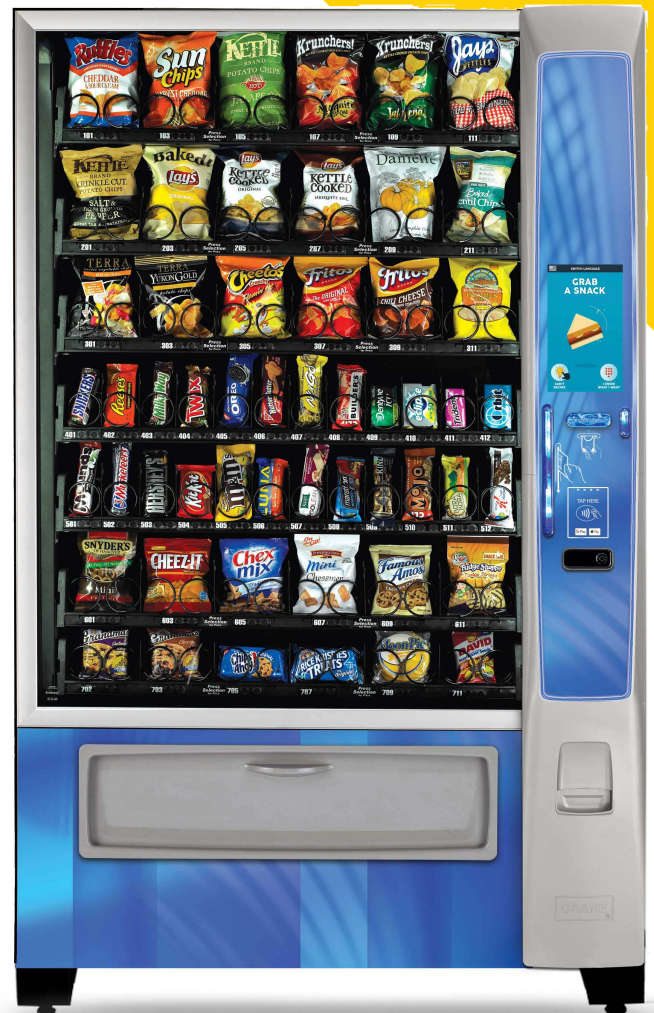

**THE FUTURE OF  
VENDING IS HERE**

## CONSUMERS ENJOY THE EXPERIENCE

### Shopping Convenience

Consumers enjoy shopping at their own pace and can engage directly with the Brand.

### Visual Display

Peak consumer interest with a larger, 9-inch color touchscreen and full-motion video.

### Suggestive Selling

Entice consumers with new products, slow movers, and complimentary selections.

### Shopping Cart

Enable consumers to make multi-product purchases from a single transaction.

### Product Information

Inform consumers with a large display of easy-to-read product facts.

## CPG BRANDS REAP THE REWARDS

### Extend Brand Presence

Reach new end locations with branded unattended machines that are open 24/7, don't need staff and never run out of products.

### Unlock new Omni Channel Strategy

Differentiate from competitors and get in front of consumers with a controlled access machine that helps in last mile distribution and theft control

### Digital Advertising

Boost purchases and build brand loyalty with display advertising and interactive promotions throughout the purchase cycle.

### Low Operating Costs

Extremely efficient refrigeration system and highly insulated cabinet construction ensures low operating costs.

### Incredible Variety

Increase sales and consumer satisfaction by providing the best product selection in the industry.

### Integrated Cashless Payment

Capture every sale seamlessly with a built-in, intuitive cashless payment solution.

### Remote Management

Manage machines in the cloud with Simplifi Connect Plus to update pricing, and access planograms.

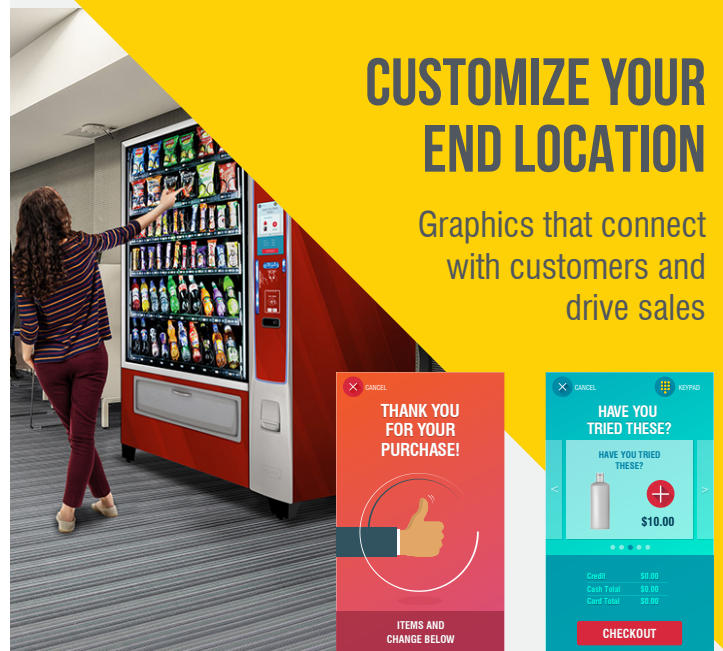

## CUSTOMIZE YOUR END LOCATION

Graphics that connect with customers and drive sales

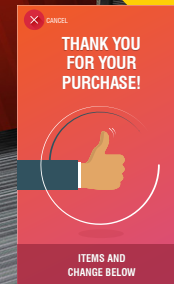

Color Display

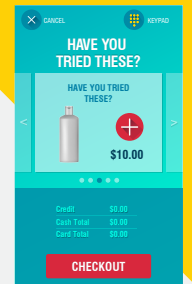

Suggestive Selling



Shopping Cart



Product Info

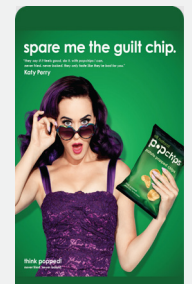

Digital Advertising

### MERCHANT AMBIENT MEDIA2 SPECIFICATIONS

Model	186 4-Wide	187 6-Wide
Height	72"	72"
Width	33"	44"
Depth	37.5"	37.5"
Weight	493 lbs	627 lbs
Electrical	115 VAC	115 VAC
	60 Hz	60 Hz
	3A*	3A*
Selection	38 - 48	58 - 72

Available certifications: UL, cUL, FCC, CE  
Green Environmentally Friendly Refrigeration System with 1/3 HP Compressor

Learn more about Merchant Ambient MEDIA2  
[www.cranepi.com](http://www.cranepi.com)

# STANDARD CONFIGURATIONS:

## MERCHANT 4 SNACK & CONFECTIONERY

11	15	13	11	Snack				
9	9	9	9	Snack				
11	15	13	11	Snack				
17	17	17	17	20	20	15	15	Confectionery
17	17	17	17	20	20	15	15	Confectionery
11	9	9	11	Snack				
17	20	20	15	Snack				

Snack 248  
Confectionery 276  
Total 524

## MERCHANT 6 SNACK & CONFECTIONERY

11	15	15	15	13	11	Snack						
9	9	9	9	9	9	Snack						
11	13	15	15	13	11	Snack						
17	17	17	17	20	20	20	20	15	15	15	15	Confectionery
17	17	17	17	20	20	20	20	15	15	15	15	Confectionery
11	9	9	13	13	11	Snack						
17	17	20	20	15	15	Snack						

Snack 380  
Confectionery 416  
Total 796

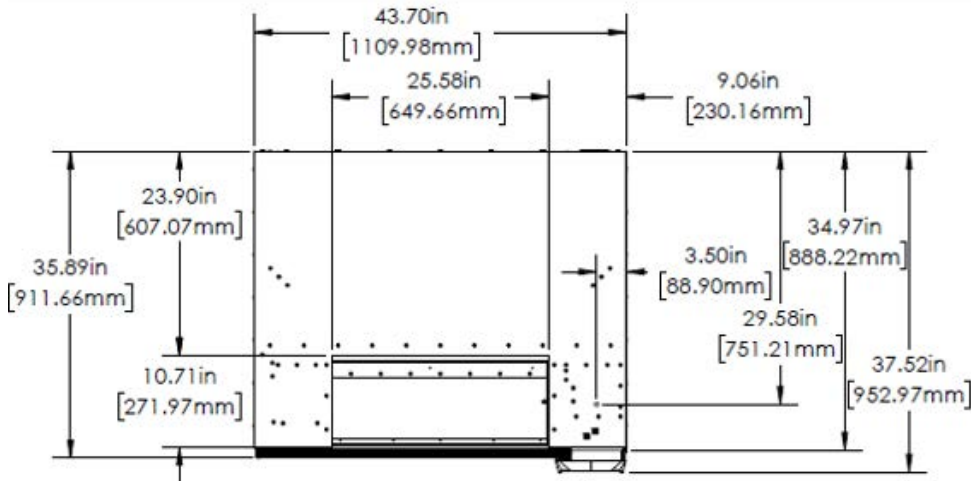

187

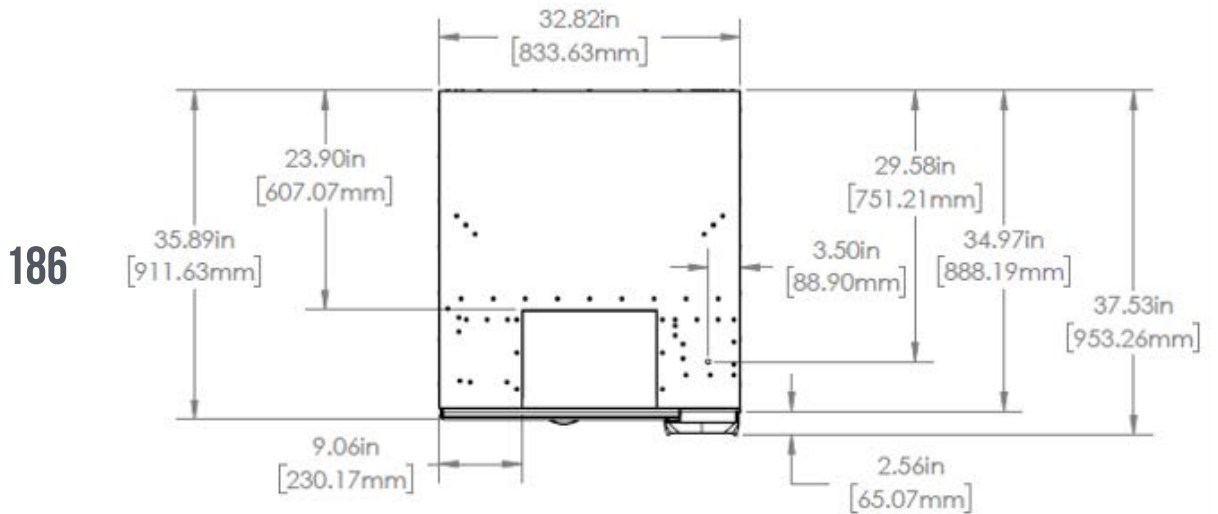

186



## EMEA APAC Headquarters

Pipsmore Park, Bumpers Farm Industrial Est. Chippenham, Wiltshire SN14 6NQ, UK  
t: +44 (0) 1249 444 807 | f: +44 (0) 1249 444 819 | sales@cranems.eu | www.cranems.eu